

MICRO

BL-111

■ Names of the parts

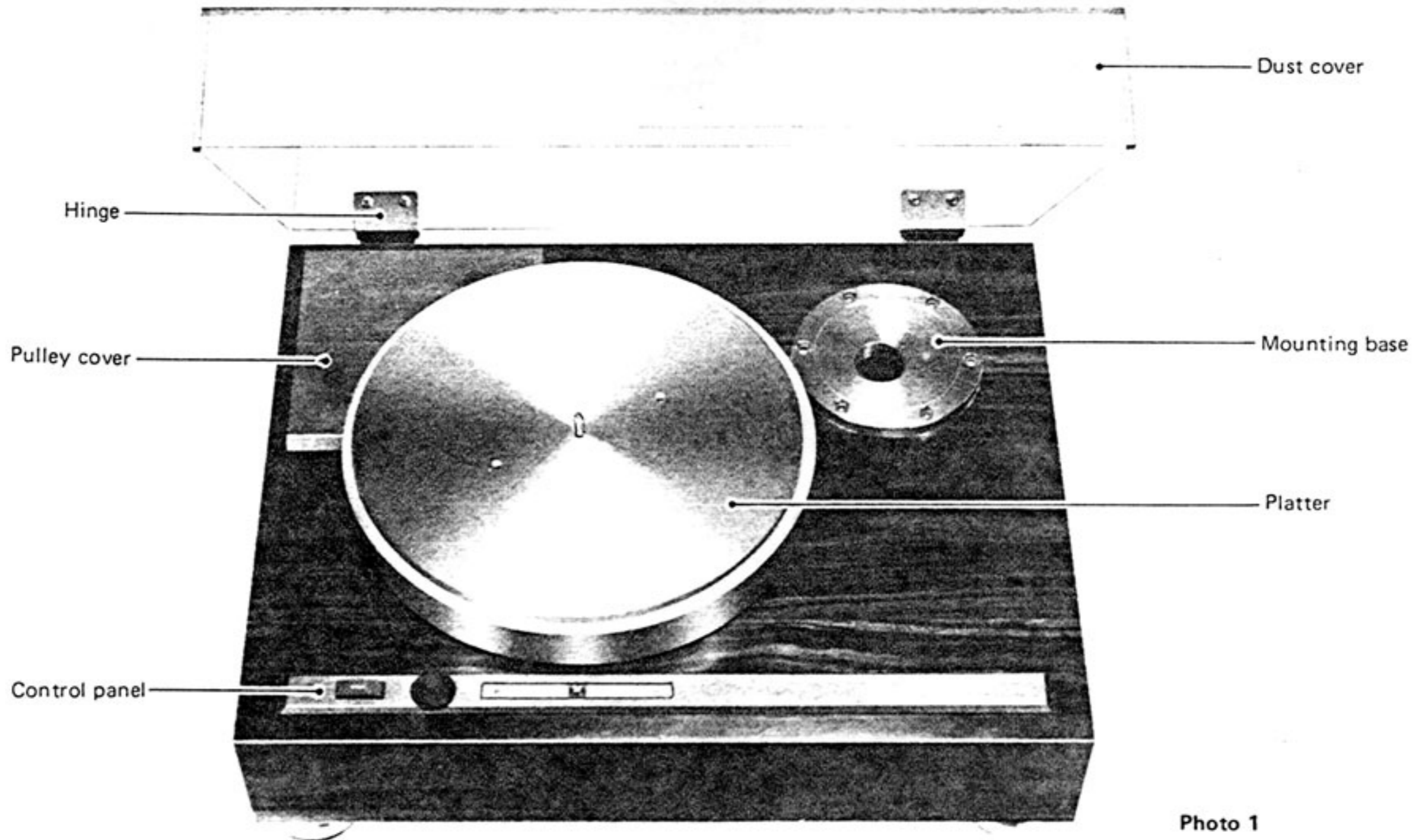
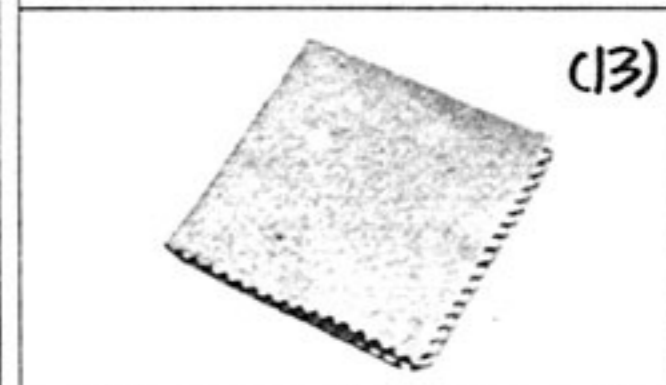
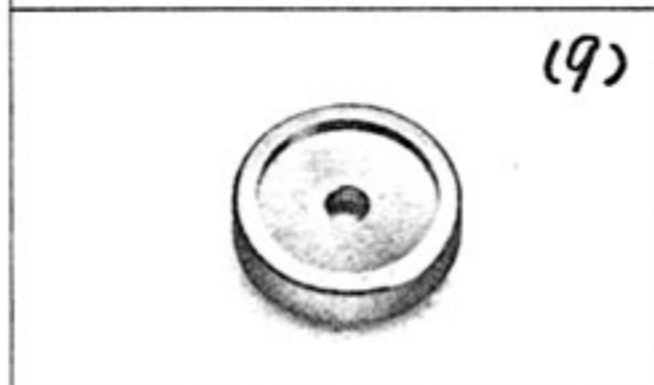
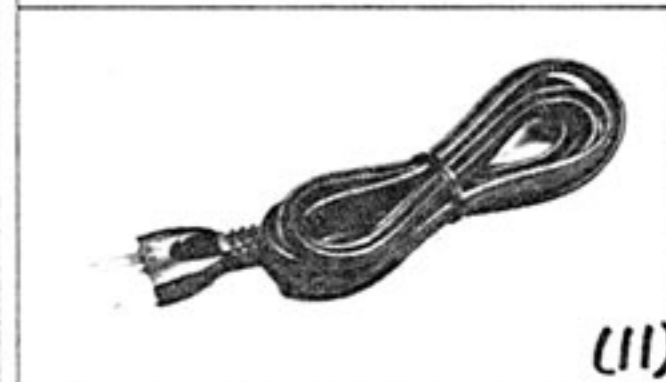
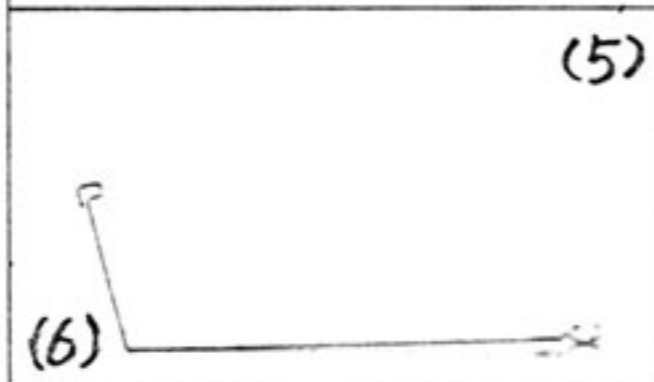
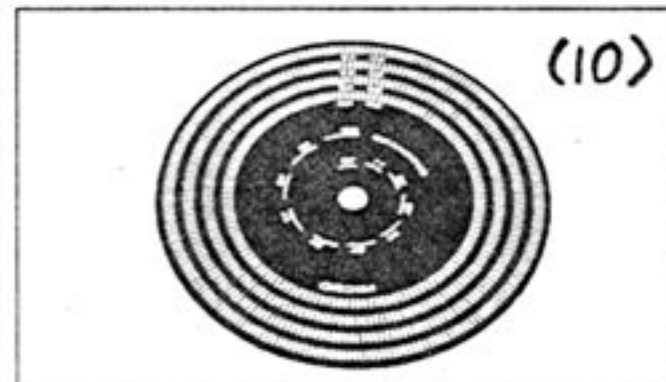
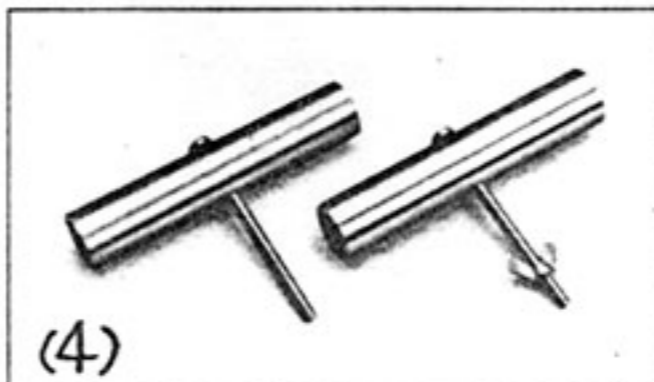

Photo 1

■ Accessories

- (1) Dust cover (packed separately)
- (2) Platter (packed separately)
- (3) Mounting base (packed separately)
- (4) Handle
- (5) Drive thread (spare provided)
- (6) Threading angle
- (7) Hexagonal wrench
- (8) Mounting base screws
M5 x 25 (6); flat washers (1)
- (9) 45 rpm adapter
- (10) Strobe mat
- (11) Power cord
- (12) Ground wires (2)
- (13) Polishing cloth



■ **Assembling the platter**

● **Mounting the platter**

Use the accessory handles to take out the platter. Remove one of the handles, tighten the threading angle together with the butterfly nut accessory to the handle and mount. (Photo 3)

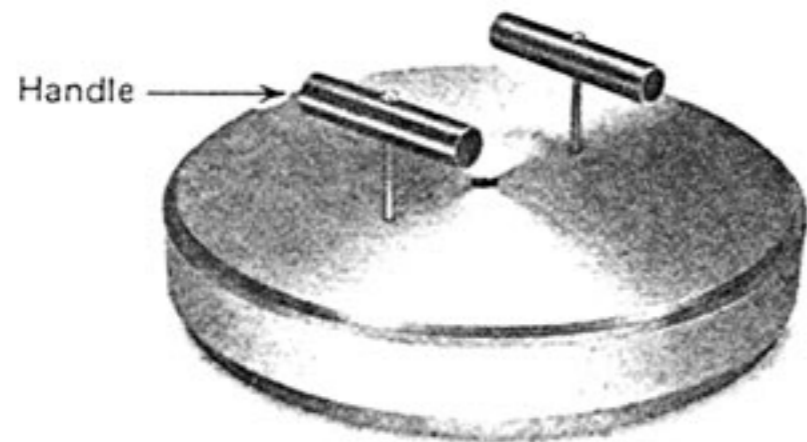

Threading angle

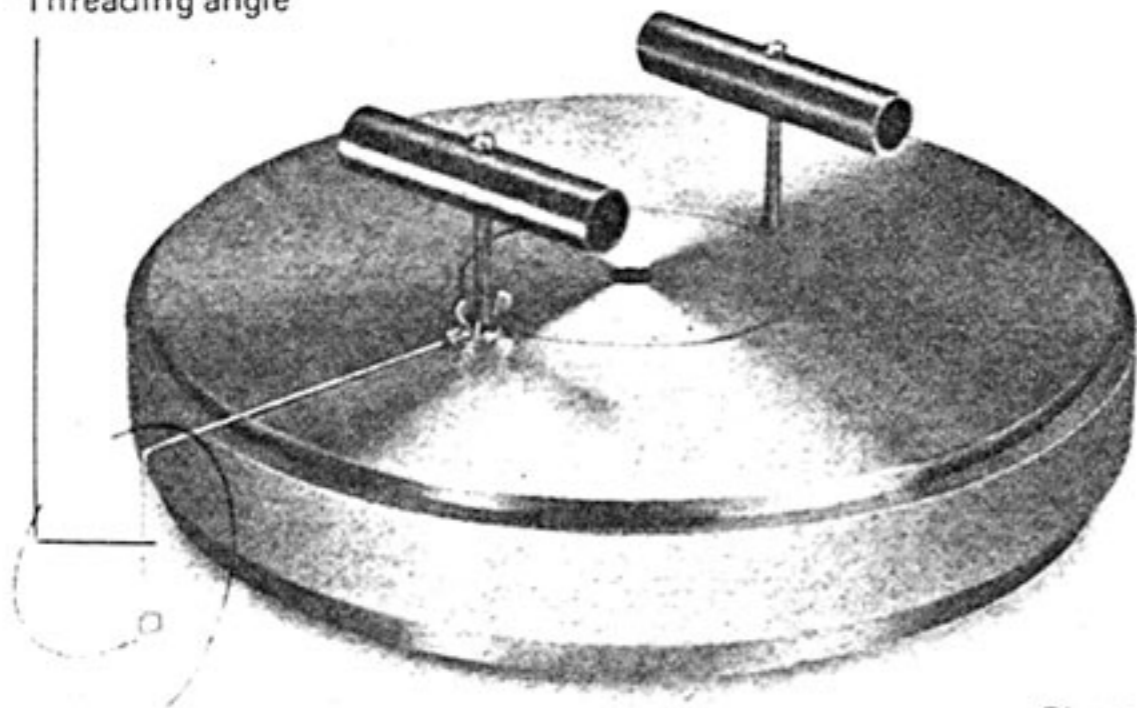

Photo 3.

Stand the platter vertically, take out the accessory drive thread and then attach it to the bottom of the platter. Pass one end of the thread loop over the threading angle. (Photo 4)

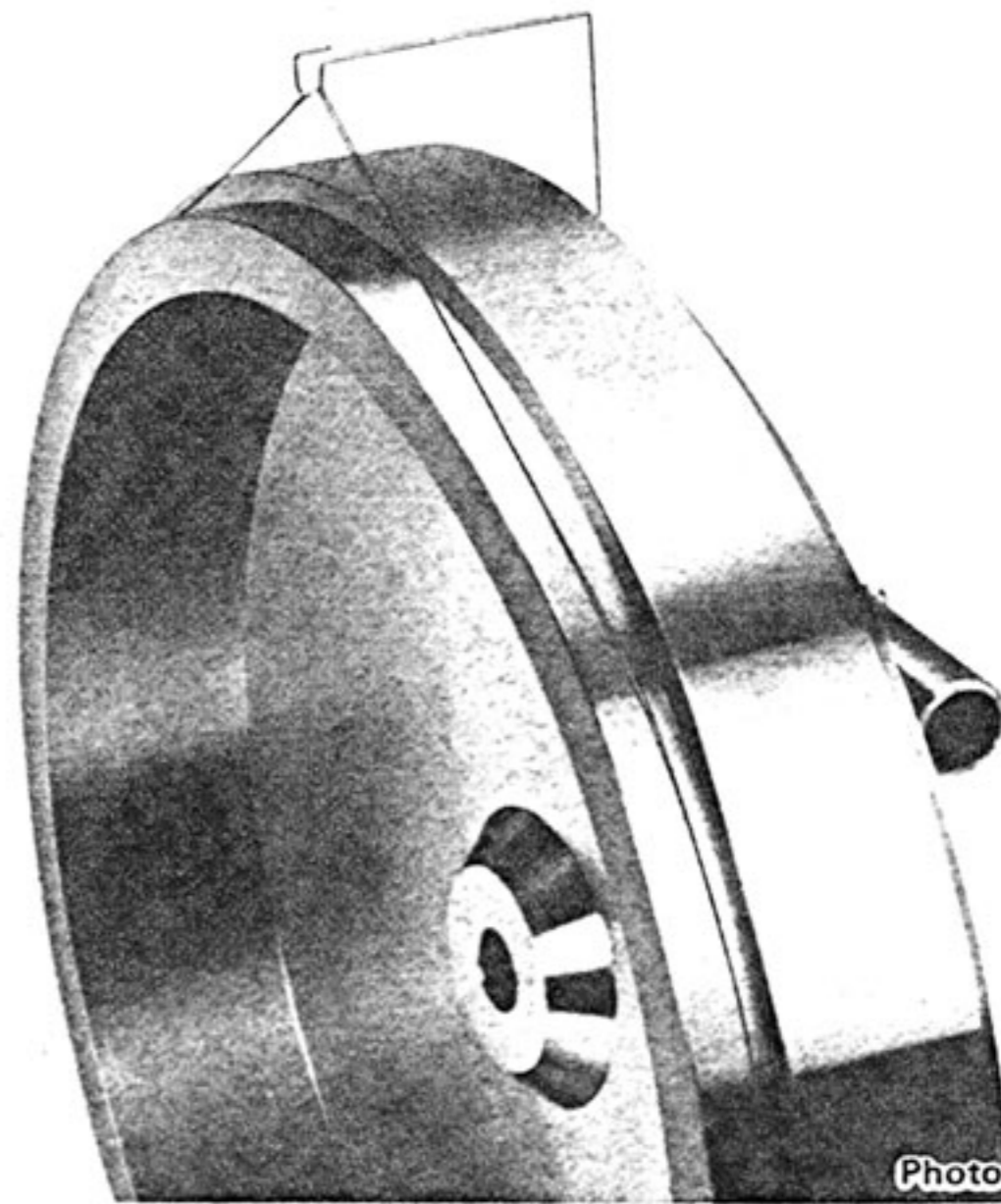
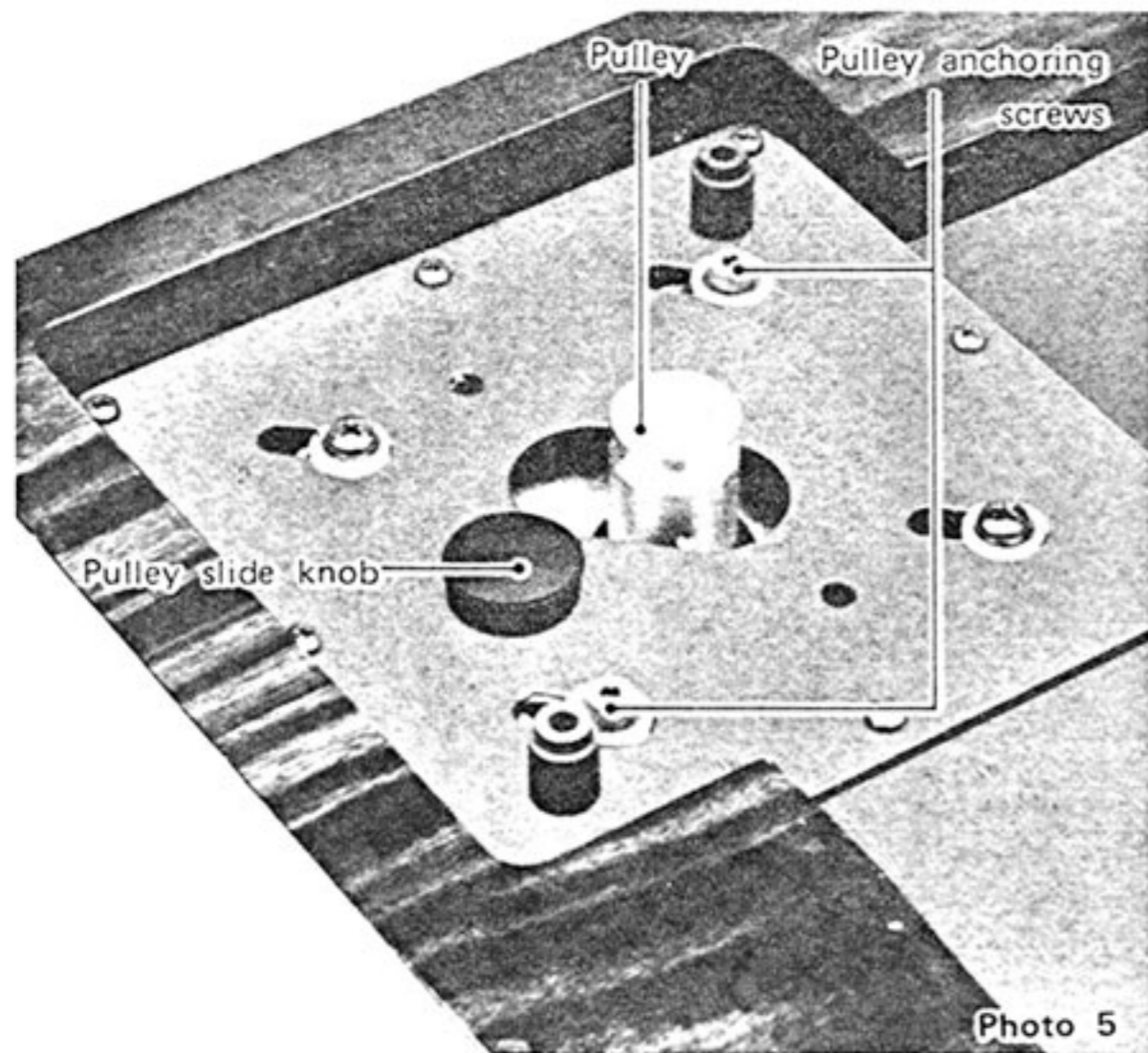
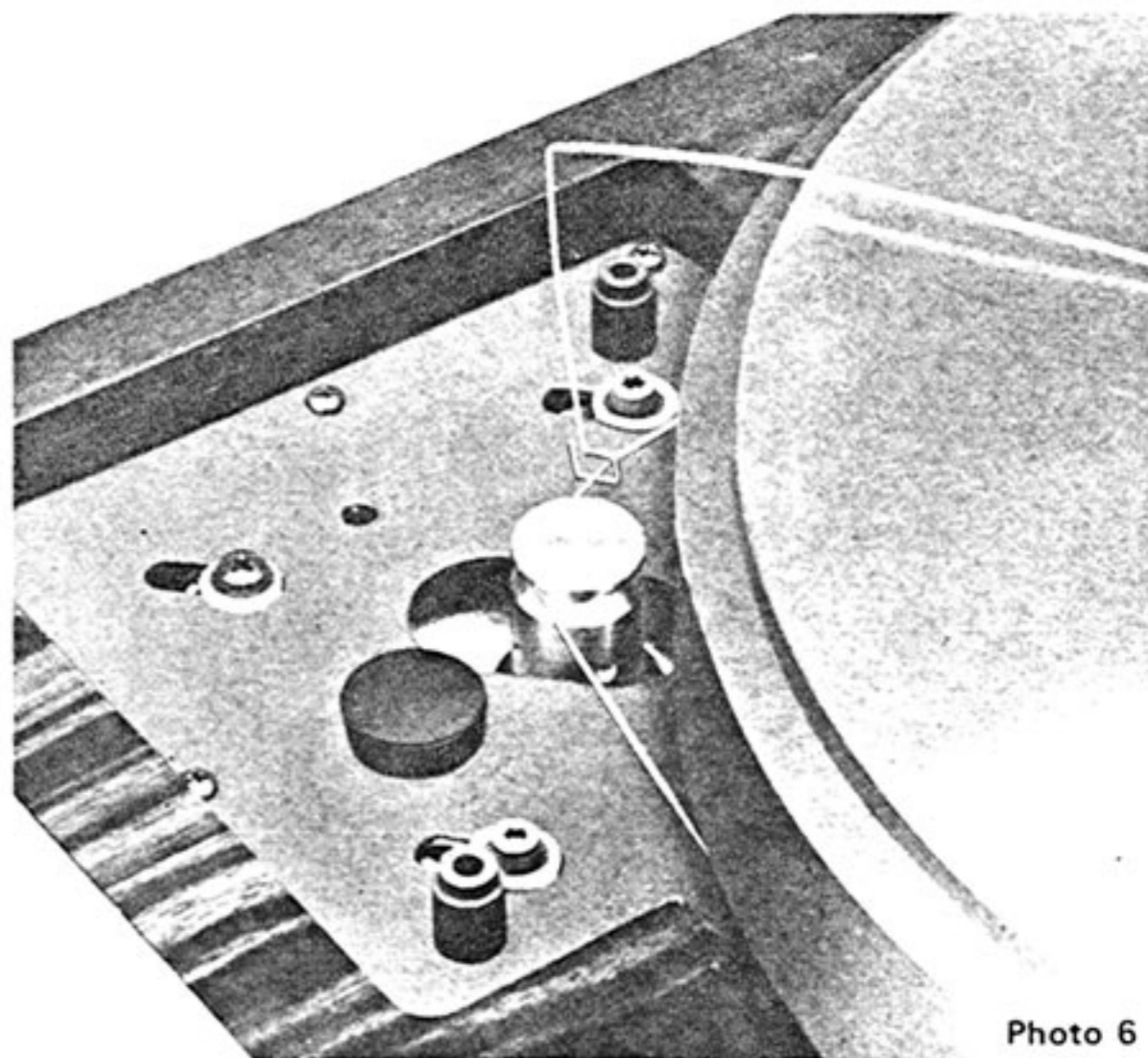

Photo 4.

When the three screws for anchoring the pulley cover are loosened, these are not detached completely from the cover but remain in position with a certain amount of play. Take hold of these screws and remove the pulley cover. Use the accessory hexagonal wrench to loosen two of the anchoring screws and then move the pulley slide knob and check that the pulley is at the innermost position. (Photo 5)



Next, with the platter as shown in Photo 4, mount it onto the shaft. Take care to ensure that the platter hole is not bumped against the shaft. Pass the drive thread along the pulley groove, rotate the pulley slide knob and move the pulley to the outside. The tautness of the thread should allow for a small amount of slack, which can be confirmed with your finger. After adjustment, tighten up the pulley anchoring screws. (Photos 6 and 7) After adjustment, detach the drive thread from the end of the threading angle and remove both the handle and the angle.



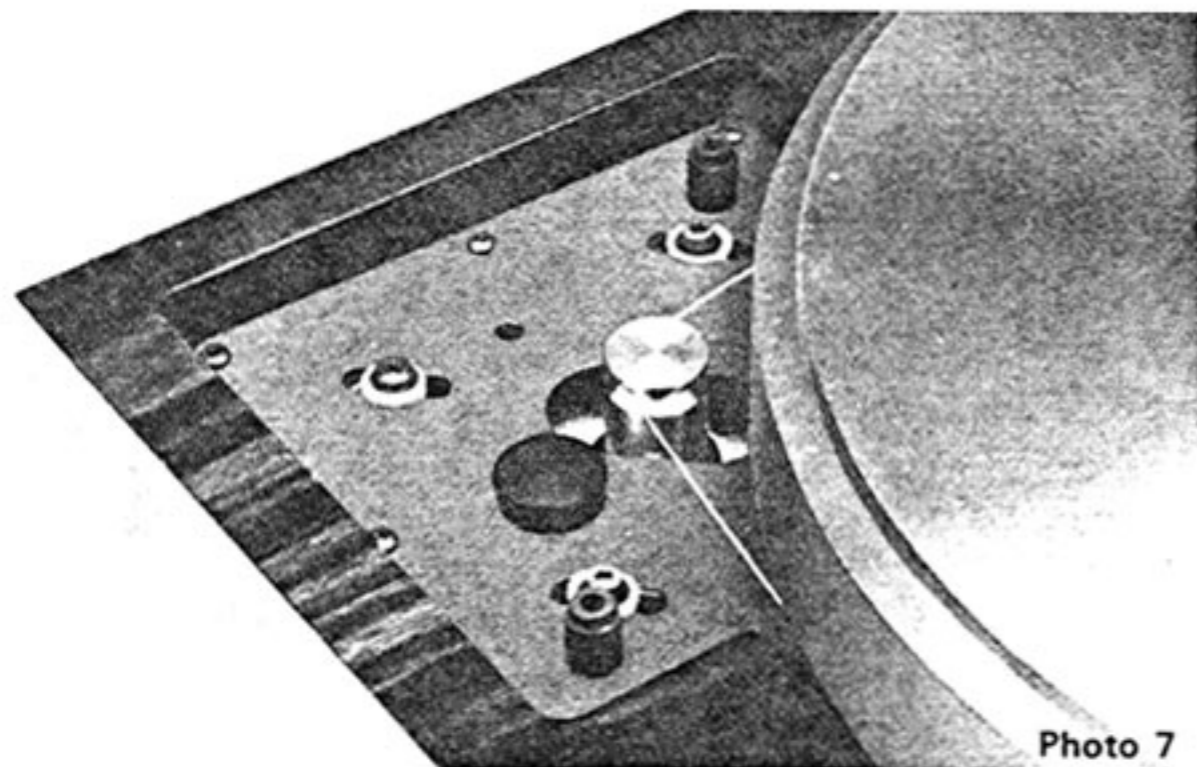

Photo 7

After having attached the thread, rotate the platter two or three revolutions by hand and check that the pulley and platter rotate together smoothly.

Switch on the power and check that the pulley does not rotate by itself when the platter starts revolving. Now mount the pulley cover so that it falls neatly into place on the cabinet, taking care not to mark the cabinet.

Notes:

Take care to avoid any adherence of oil or other matter on the parts that come into contact with the thread on the platter and pulley.

The platter is made of gunmetal and so crystals may sometimes appear to be floating on the surface. This is not indicative of a defect in the finish. The platter has been given a layer of clear paint to prevent dirt from adhering and so it should never be wiped with any substance containing alcohol or with a thinner of any kind since this will cause discoloration and corrosion.

■ **Mounting the tonearm**

● **Selecting the mounting base (A-1200 series)**

Select the mounting base in accordance with the tonearm which you intend to use. Special work is required to accommodate tonearms which are not listed below. A mounting base is provided with the BL-111 but a second base is optional.

(Special work is required to accommodate tonearms which are included in the above list.)

■ **Compatible tonearms**

A-1201

MICRO/MA-505X, S, 707X
 AUDIO CRAFT/AC-300MKII
 SAEC/WE-407/23
 TECHNICS/EPA-99

A-1202

SAEC/WE-308N, 308SX

A1203

FR/FR-64, 64S, 14
 DENON/DA-303, 305, 307, 399, 401
 VICTOR/UA-5045

A-1205

MICRO/MA-505XII, SII, 808X
 AUDIO CRAFT/AC-3000MC

A-1206

SME/3009SII, SIII

■ Setting the tonearm

First, provisionally anchor the tonearm to the mount base and then check the designated overhang. Now secure the tonearm properly to the mounting base and then attach the base to the cabinet using the accessory screws (M5 x 25) as shown in Fig. 1.

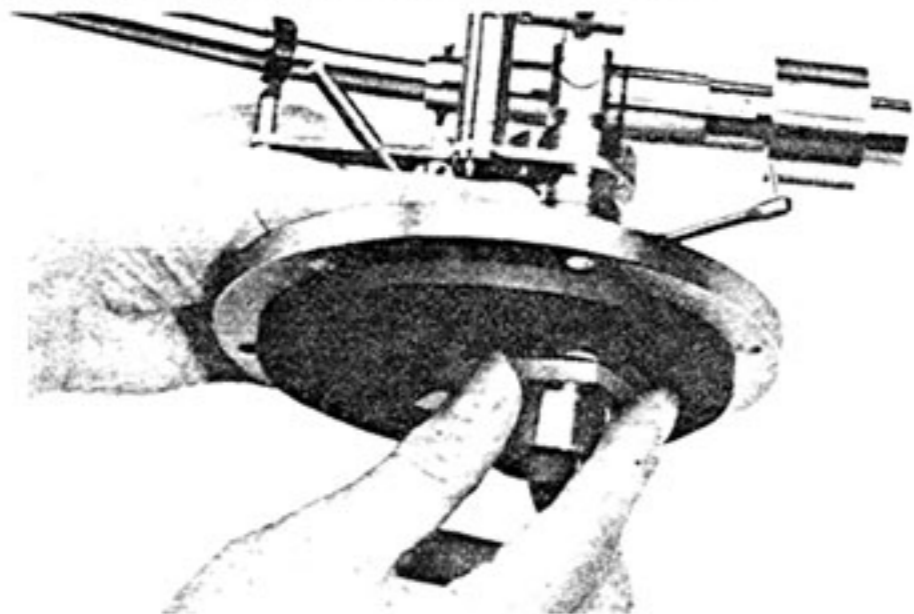

Photo 8

● Mounting position of base

Mounting the mounting base with the index mark aligned as in Fig. 2 automatically produces the required effective length of the tonearm (except in a few cases) and the overhang.

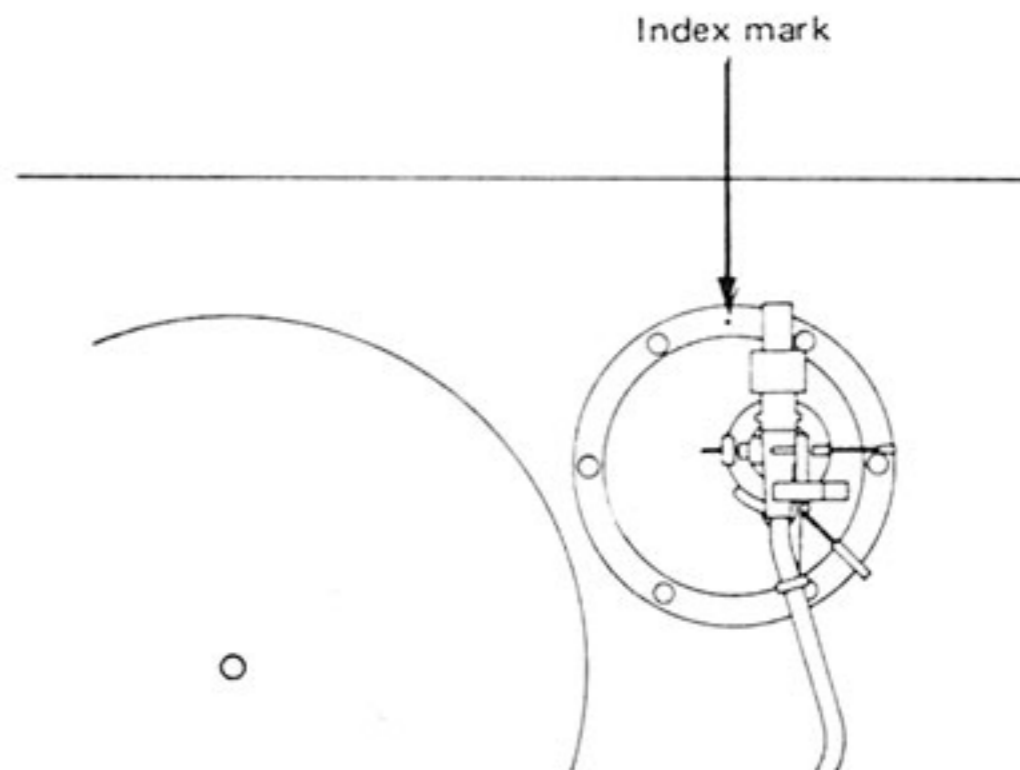

Fig. 2

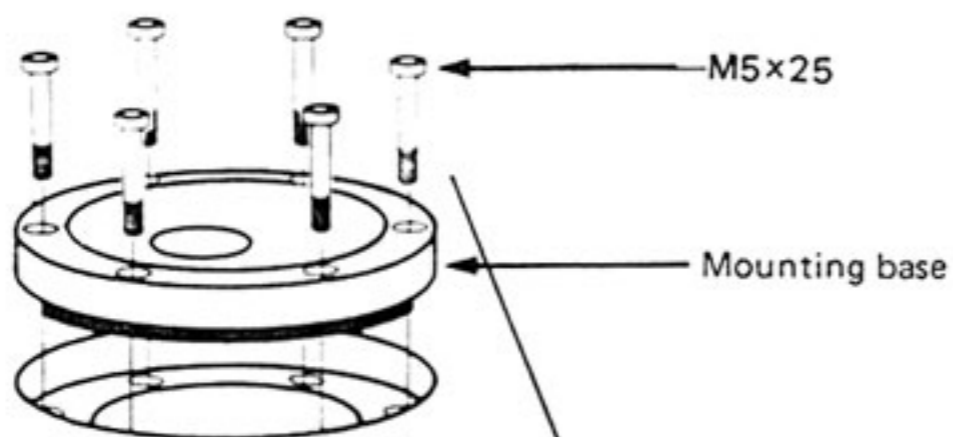

Fig. 1

- Attaching the power cord and ground wire

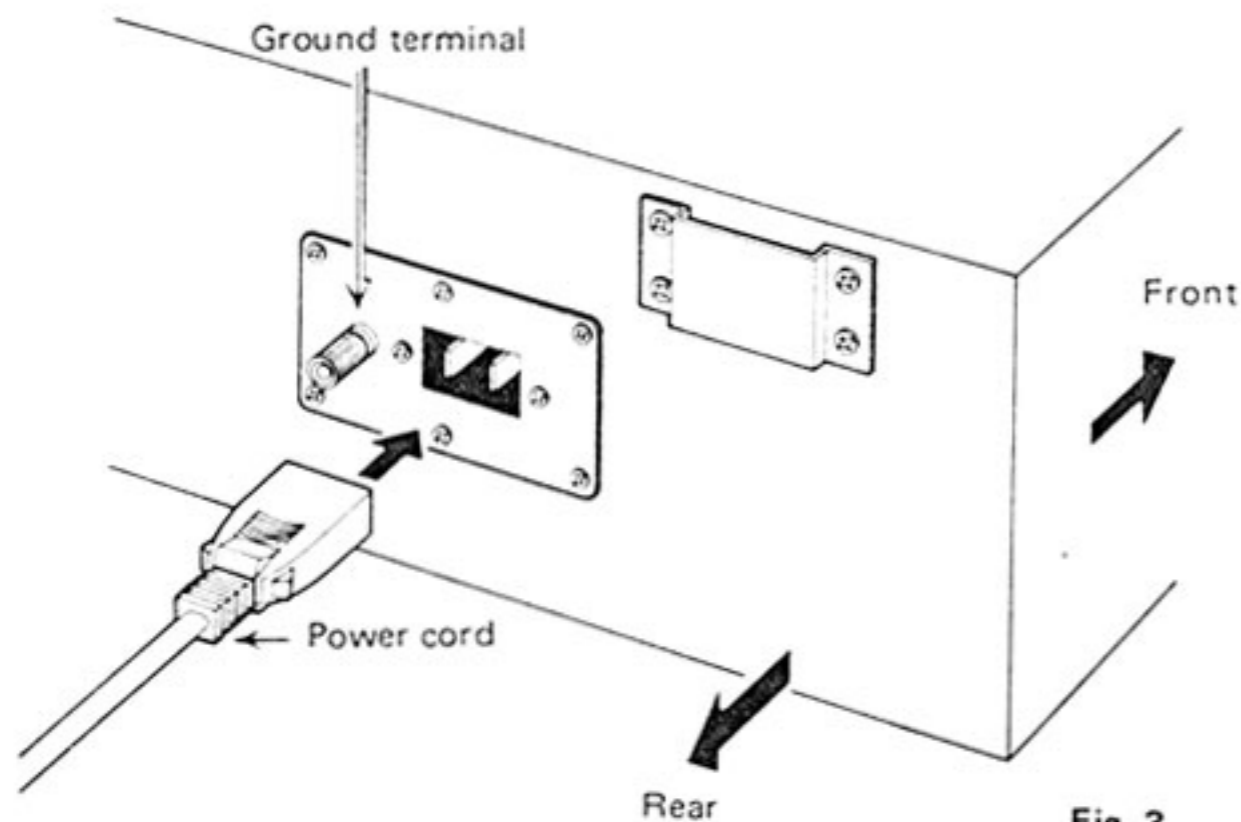
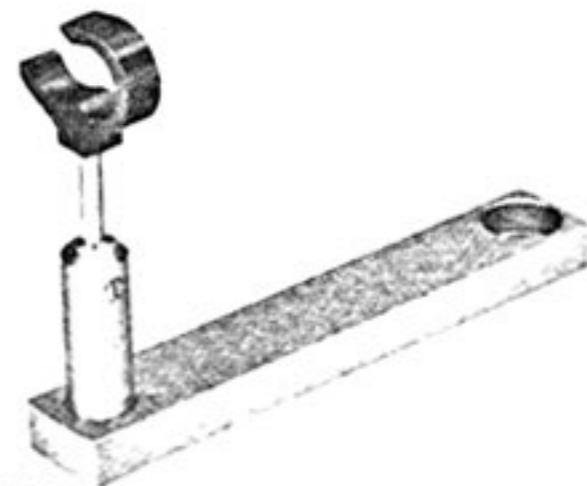
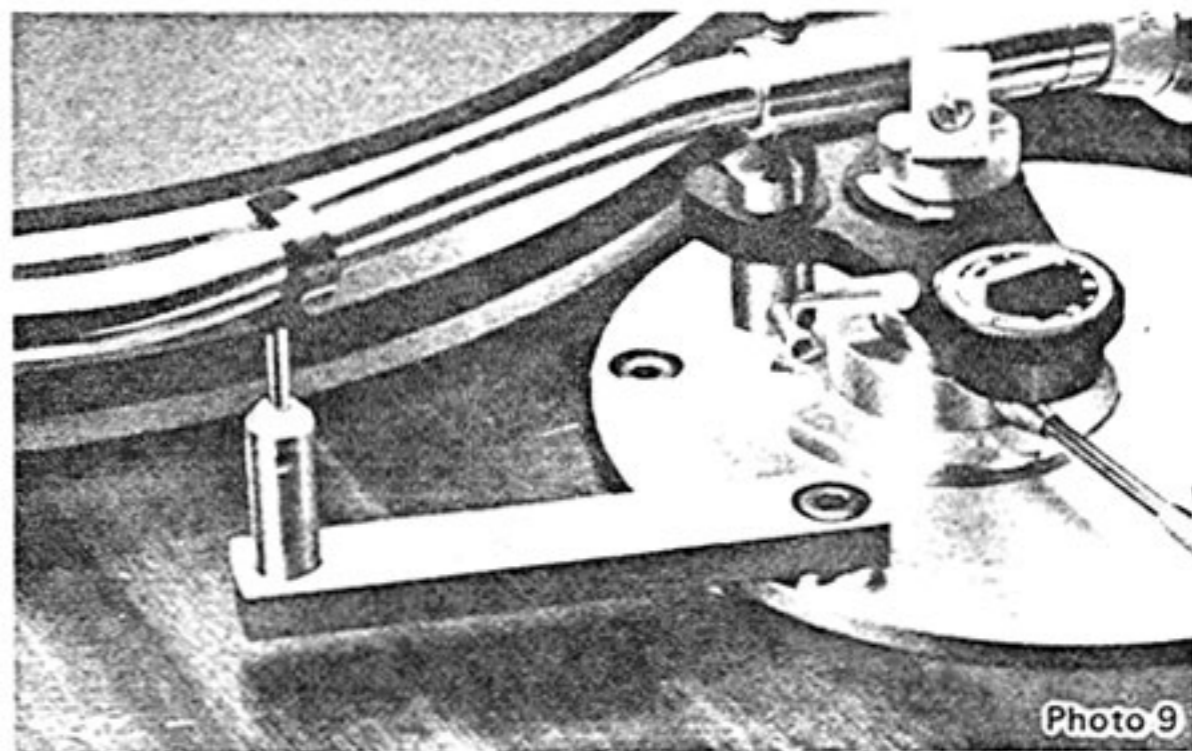

Fig. 3

The power cord is plugged into the rear panel of the turntable as in Fig. 3. One end of the accessory ground wire is attached to the ground terminal and the other end is attached to the GND terminal on the amplifier. A ground terminal is also provided near the opening on the rear panel of the turntable from which the tonearm cord is drawn out. The ground circuit of this terminal differs according to the tonearm which is used and so decide whether or not to use the ground wire in accordance with the amount of noise heard.

- Mounting the arm rest

When you are using an arm rest which is separate from the tonearm, the rest can be mounted simply without having to drill any holes in the base if you provide yourself with the optional RB-5.



RB-5 optional arm rest

Photo 10

Speed selection and adjustments

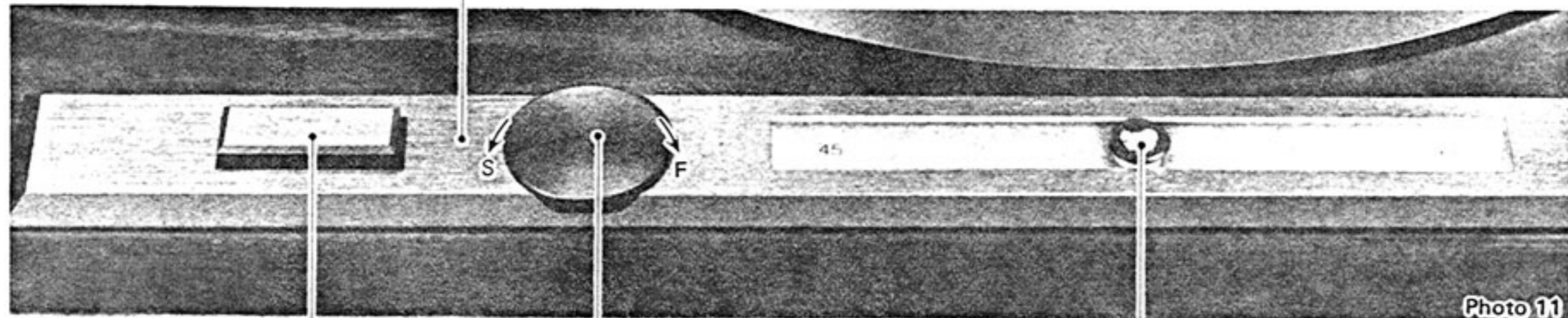

- **Power switch**

When this switch is set to the ON position, the power is supplied to the turntable and the platter starts to rotate.

- **Speed adjustment knob**

To adjust the speed, place the accessory strobo mat on the platter. It is possible to make the platter rotate up to 6% (semitone pitch) slower or faster than the rated rotational speed. The speed is increased in the "F" direction and reduced in the "S" direction.

- **Speed selector switch**

Every time this switch is depressed, the speed alternates between 33 and 45 rpm. Select the position in accordance with the rated speed of the record being played. When the power switch is set to ON, the speed is automatically set to 33-1/3 rpm.

- Mounting and adjusting the dust cover

- Mounting the dust cover

Fit the projection in the dust cover bracket into the cutout in the turntable bracket and insert in the direction of the arrow to mount.

(Photo 12)

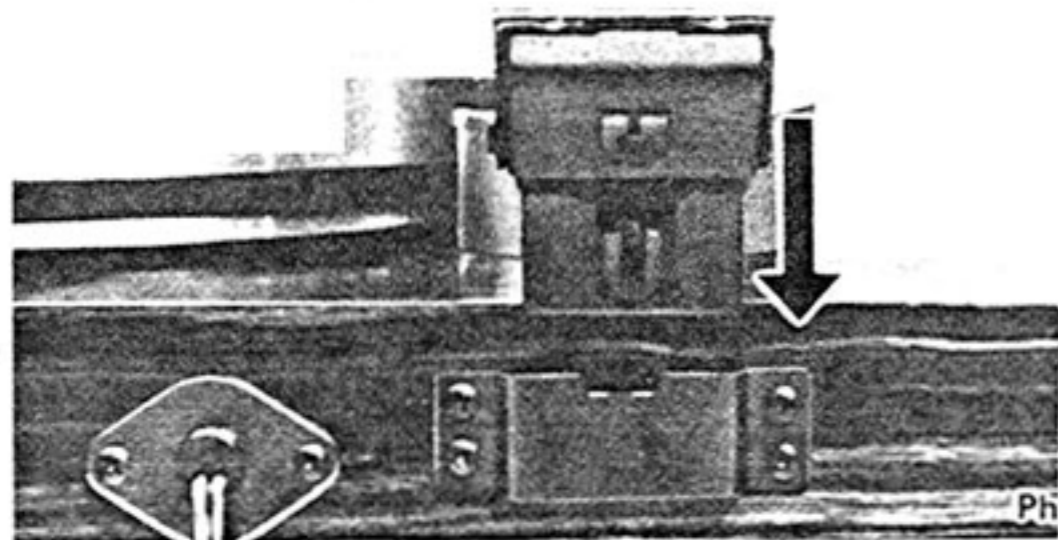

Photo 12

A free-stopping type of dust cover is used. If the cover does not close completely or if it closes without stopping, adjust the screw shown in Photo 13.

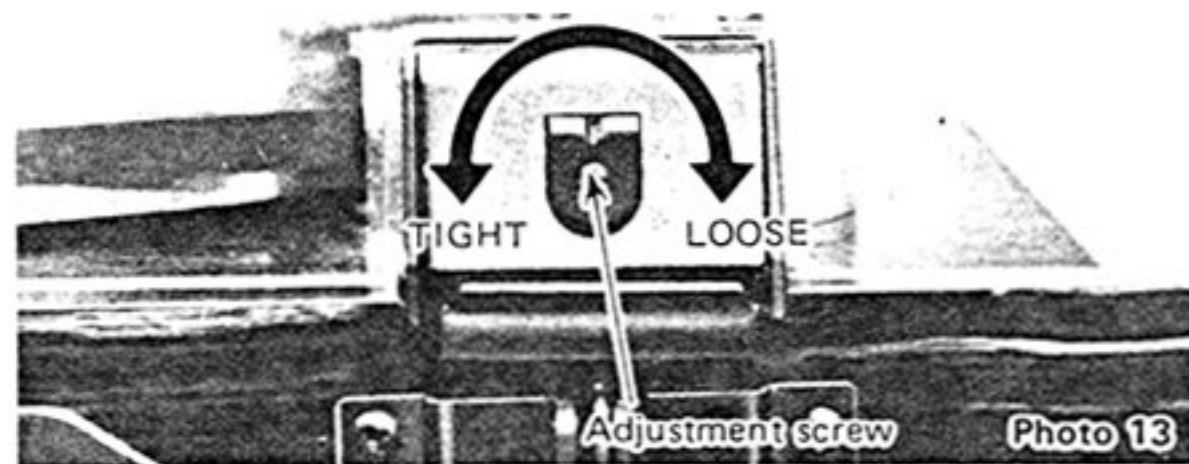

Photo 13

- Handling precautions and maintenance

- Center shaft wear

The center shaft used in the BL-111 features a construction which employs an oil bath system to resist loads and aging. This is a semi-permanent system that is maintenance-free and does not require the oil or bearings to be replaced. The durability of the center shaft is guaranteed and should any trouble result under normal conditions of use, it will be replaced by MICRO gratis.

Note: Under no circumstances should the rear cap of the center shaft be removed. Removal of this cap will result in the sealed oil spilling out and other trouble. (Photo 14)

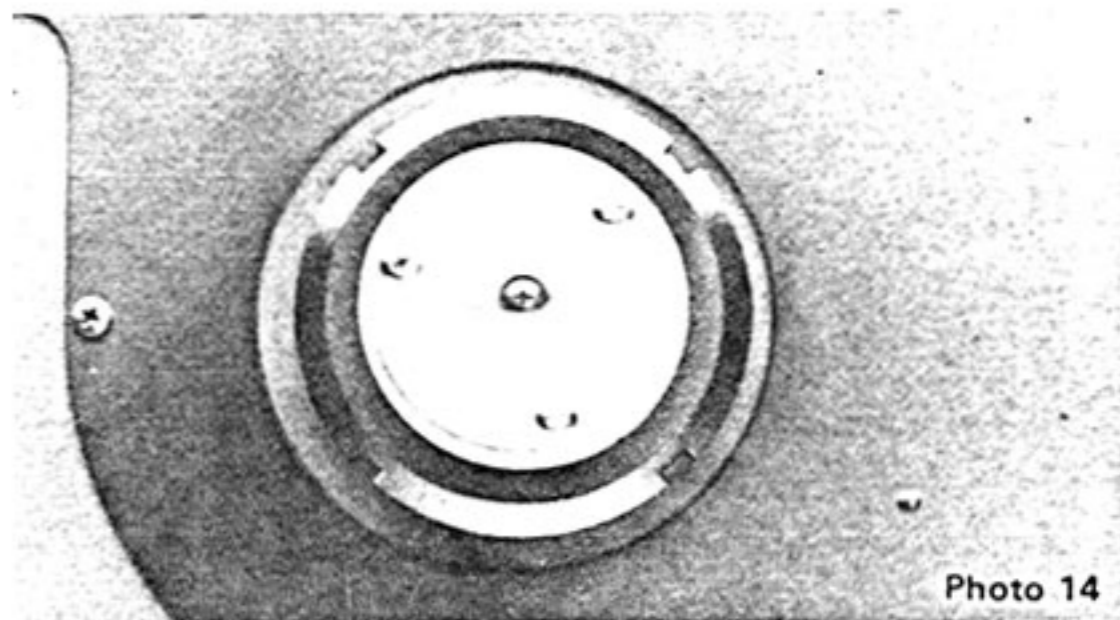

Photo 14

- Replacement period for thread

Replace the thread from time to time in order to maintain its initial characteristics. The replacement period differs according to its use but once it becomes too dirty or appears to have worn with friction, it should be replaced.

After you have used the spare, obtain the K-5 replacement thread from your MICRO dealer.

■ **Looping the drive thread with the K-5 replacement thread**

- (1) Cut the thread into a length of 1010 mm.
- (2) Tie the thread together and shape it into the length shown in Fig. 4.

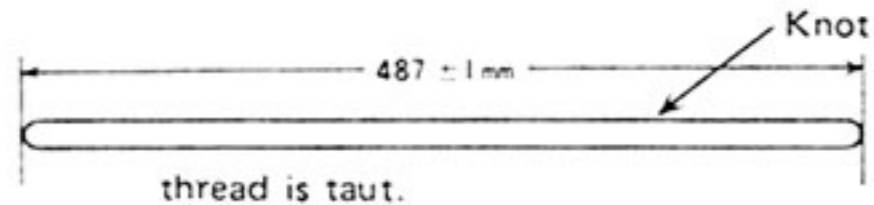

Fig. 4

● **Oiling the motor**

The BL-111 motor uses a special oil which obviated the need for oiling as such. Usage of any other type of oil may result in a malfunction or trouble. (If there is anything wrong with the motor, contact MICRO's Servicing Department.)

● **Installing the turntable**

- (1) If the turntable is installed near an amplifier or near equipment using a transformer, it will be affected by flux and hum will be generated as a result. In particular, MC cartridges are very susceptible to the effects of flux and so the turntable should be installed as far away from amplifiers as possible.

(Examples of poor installation)

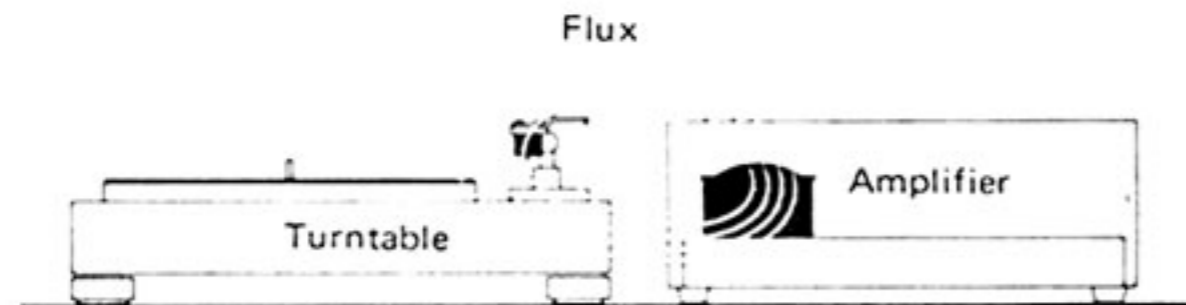

- (2) The reproduced sound will deteriorate if the turntable is exposed to vibration. Where possible, install it on a sturdy stand. The sound quality is enhanced if a glass panel or marble slab is used. Avoid installing the turntable directly in front of the speakers (where it will be exposed to the sound waves) or on top of the speakers. Leave as large a clearance with the wall as possible when installing against a wall. Failure to comply with these instructions may result in howl (acoustic feedback).
- (3) Do not install the turntable at an angle but select a location which is completely horizontal.

■ **Specifications**

● BL-111	
Drive system	Thread drive
Rotational speeds	33-1/3 and 45 rpm
Speed adjustment range	± 6%
Platter	31 cm diameter, 10 kg (gunmetal)
Moment of inertia	1,500 kg.cm ²
Dimensions	532(W) x 440(D) x 230(D) mm
Weight	36 kg

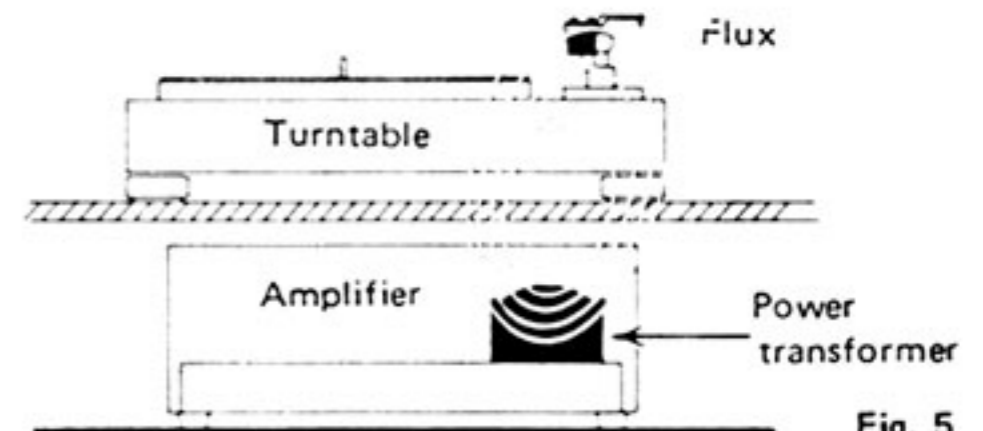

Fig. 5

 **MICRO SEIKI CO.,LTD.** TOKYO JAPAN

Printed in Japan