

Title		
Size	Number	Revision
A3		
Date	19.05.2015	Sheet of
File	F:\Проекты\YES-3.2-L\YES-3.2-L.dwg	by

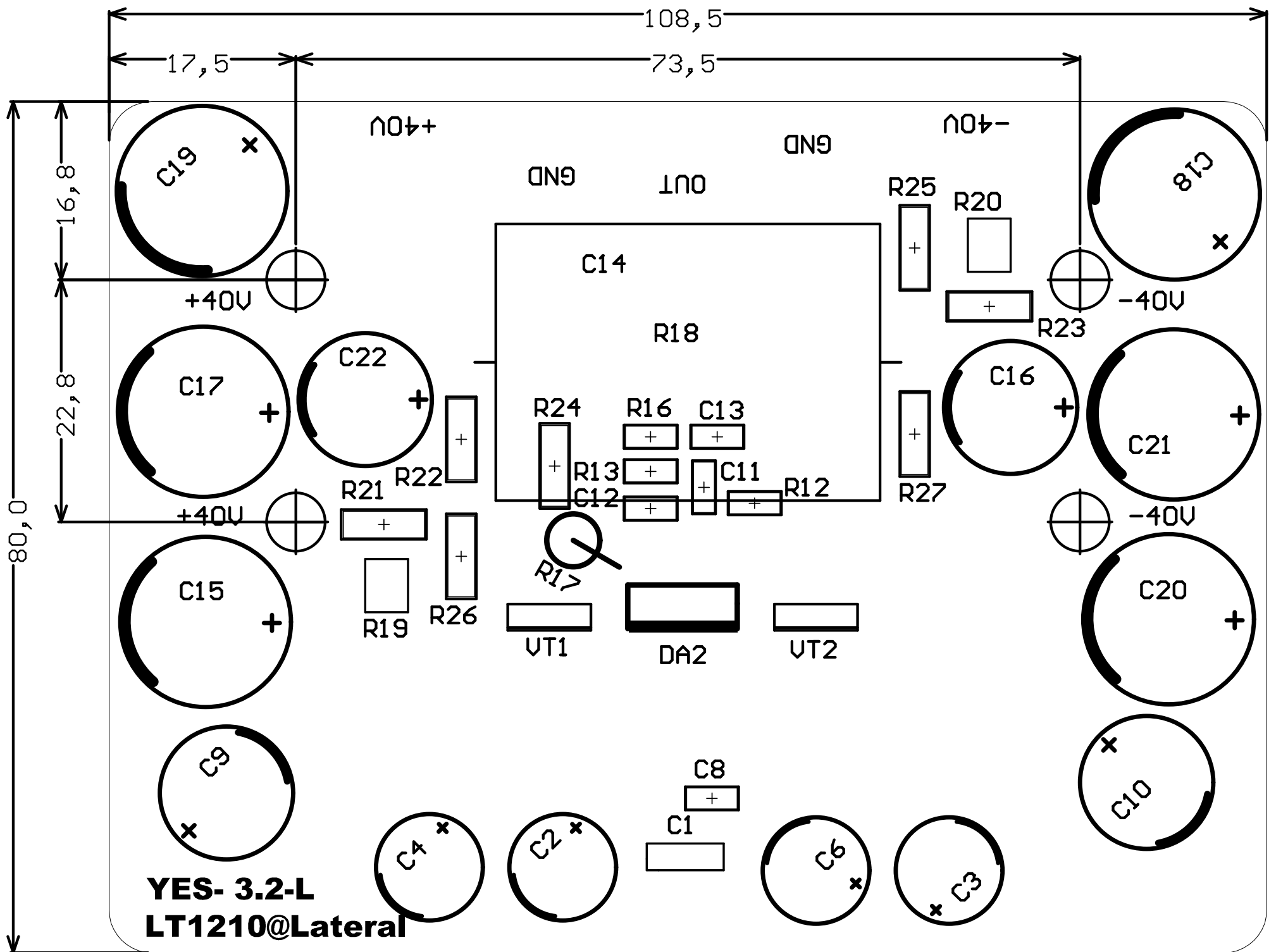

108,2

80,0

GND

OUT

GND

-40V

+40V

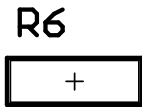
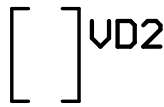
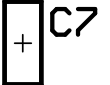
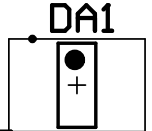
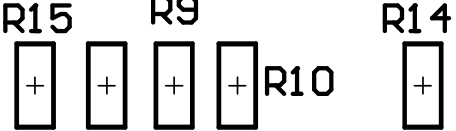
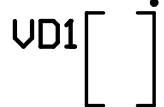
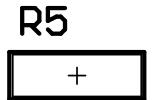
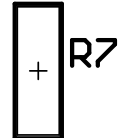
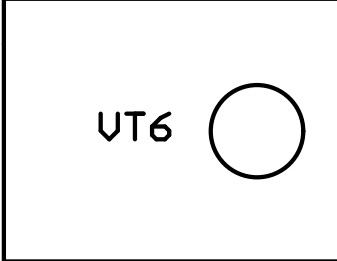
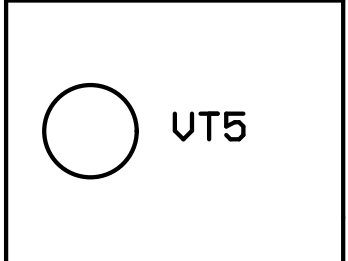
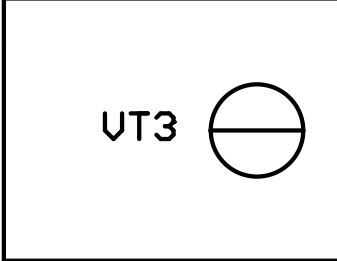
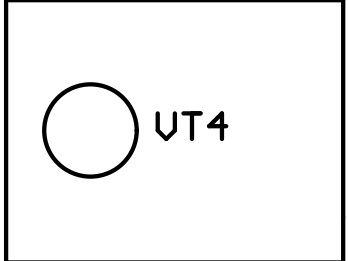

Bill of Materials

YES-3.2-L

Source Data From:

YES-3.2-L.PrjPcb

Project:

YES-3.2-L.PrjPcb

Variant:

None

Creation Date: 19.05.2015 20:34:28

Print Date: 42143 42143,86841

Designator	Comment	Footprint	LibRef	Quantity
C1	150	B32529C3223	Capacitat	1
C2, C6	330мкФ	C10x20	Cap Polar	2
C3, C4	680мкФ	C10x20	Cap Polar	2
C5, C7	0.1мкФ	Cap1206	Capacitat	2
C8	62	Cap1206	Capacitat	1
C9, C10	820мкФ	C12.5x31	Cap Polar	2
C11	24	Cap1206	Capacitat	1
C12, C13	10нФ	Cap1206	Capacitat	2
C14	10мкФ	GG 26x32	Capacitat	1
C15, C17, C18, C19, C20, C21	2200мкФ	C16x31	Cap Polar	6
C16, C22	560мкФ	C12.5x31	Cap Polar	2
DA1	AD845	R-PDSO-G8	AD8065	1
DA2	LT1210	TO-220(7)	LT1210	1
R1	56к	1206	Resistor	1
R2, R3, R4, R9, R10	1к	1206	Resistor	5
R5, R6, R7, R8	680	0207	Resistor	4
R11, R12	24к	1206	Resistor	2
R13, R16	130	1206	Resistor	2
R14, R15	15	1206	Resistor	2
R17	12	C1-4V 2Bт	Resistor	1
R18	120	TO220(2G)	Resistor	1
R19, R20	100	3224W	VRES	2
R21, R23	33*	0207	Resistor	2
R22	5...10	0207	Resistor	1
R24, R25, R26, R27	130	0207	Resistor	4
VD1, VD2	1SMB5929BT3	SMB (DO-214AA)	Diod	2
VT1	BD139	SOT-32H	NPN	1
VT2	BD140	SOT-32H	PNP	1
VT3, VT6	2SJ162	TO-3P	MOSFET(P)	2
VT4, VT5	2SK1058	TO-3P	MOSFET(N)	2
XS1	X3		X3	1
				60